

# The Importance of Slab Edge & Balcony Thermal Bridges

## Report # 2: Impact of Slab Thermal Breaks on Thermal Comfort and Condensation Control

rdhbe.com



Making Buildings Better

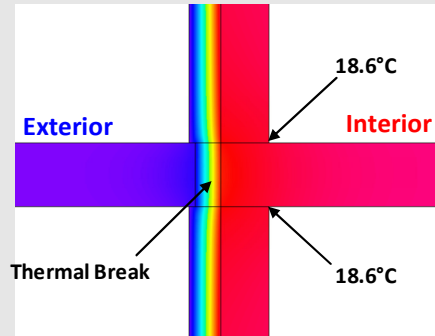
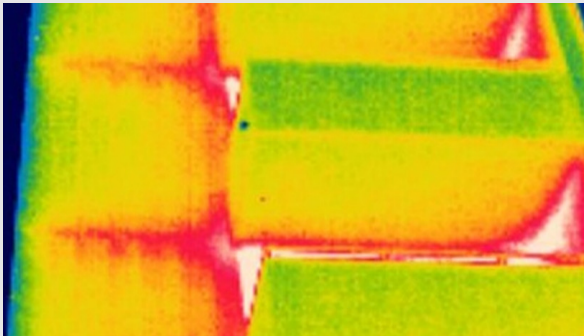
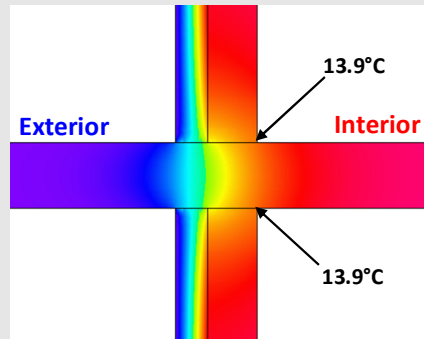
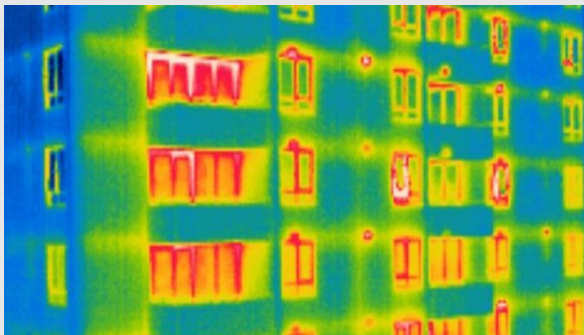

Prepared by

RDH Building Engineering Ltd.

Date

September 24, 2013

# The Importance of Slab Edge & Balcony Thermal Bridges

## Report # 2 - Impact on Thermal Comfort and Condensation Control

Thermal bridging occurs when heat flow bypasses the insulated elements of the building enclosure. Bridging occurs through structural components such as the studs/plates, framing, and cladding supports as well as the larger columns, shear walls, and exposed floor slab edges and protruding balconies. While thermal bridging occurs through the roofs, floors, and below-grade assemblies, it is often most pronounced in above-grade wall assemblies.

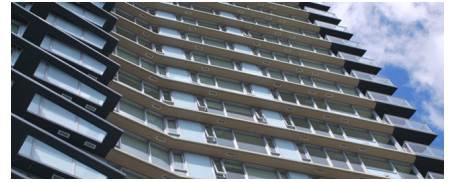

The heat flow through thermal bridges is significant and disproportionate to the overall enclosure area so that a seemingly well insulated building can often fail to meet energy code requirements, designer intent, or occupant expectations.

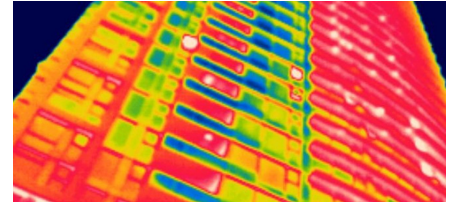

Windows are often seen as the largest thermal bridge in buildings, as the thermal performance is often quite low compared to the surrounding walls (i.e., an R-2 metal frame window within an R-20 insulated wall); however, exposed concrete slab edges and balconies can have almost as large of an influence having effective R-values of approximately R-1. After accounting for windows and doors, exposed concrete slab edges and balconies can account for the second greatest source of thermal bridging in a multi-storey building.

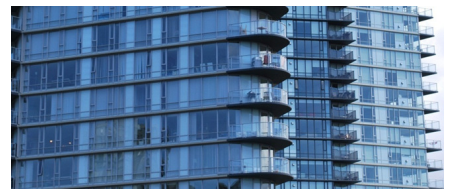

With a better understanding of the impacts of thermal bridging, the building industry has started to thermally improve building enclosures; for example, the use of exterior continuous insulation in walls is becoming more common.

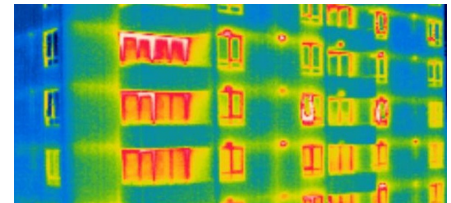

Unfortunately the impact of floor slab edges and balconies is still often overlooked. At the same time, the architectural look of exposed slab edges and protruding balconies or “eyebrow” elements is becoming more common. Many designers believe that these relatively small elements have a negligible impact on the overall performance of the building or see them as an unavoidable compromise to achieve a certain appearance. Unfortunately, the impact of exposed slab edges and balconies is very significant, as this report will demonstrate. The relative impact of these elements also increases as more highly insulated walls are required by upcoming building code changes or sustainable building programs.

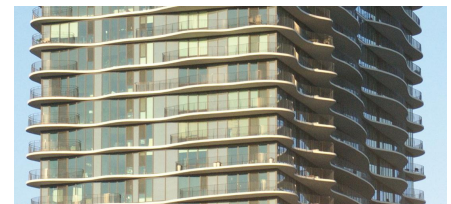

Fortunately, there are solutions available in the marketplace that help to minimize the thermal bridging impact at slab edges and balconies and allow for continued architectural design freedom under increasingly more stringent energy code requirements and occupant demands.

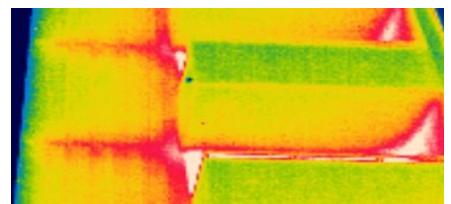

This research report addresses the thermal control, comfort, energy, and cost impacts of exposed slab edges and balconies. It provides proven solutions and discussion of their implications with respect to these parameters.

## Exposed Slab Edge & Balcony Thermal Bridge Research Study

A research project was undertaken by RDH to quantify the thermal impact of exposed slab edges and balconies in mid- to high-rise residential buildings across climate zones in Canada.

The impact of exposed slab edges and balconies on the effective wall R-values, indoor temperatures, and indoor thermal comfort was assessed. Space heating and cooling loads were also modeled in each climate zone for an archetypal multi-unit residential building to quantify the energy loss through exposed slab edges and balconies and to determine the space conditioning savings that could be achieved in typical scenarios when balcony and slab edge thermal break products are used.

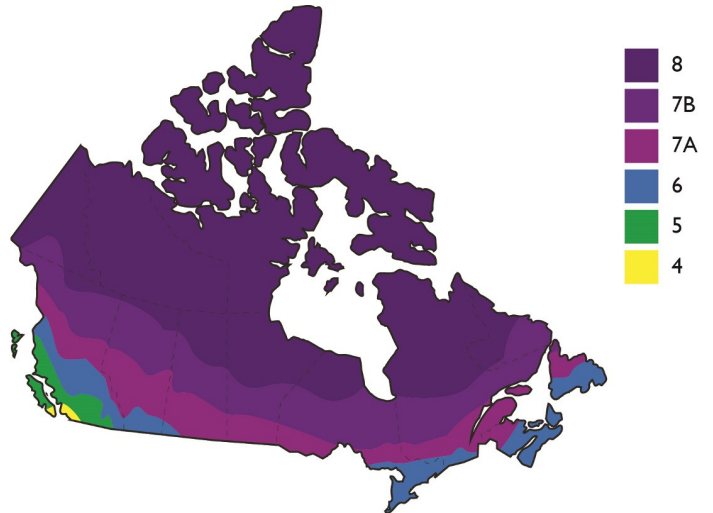

Canadian climate map showing Climate Zones 4 through 8 per the 2011 NECB. ASHRAE 90.1-2010 uses a similar climate zone map; however, Zone 4 is bumped into Zone 5 due to differences in reference climate data between NECB and ASHRAE.

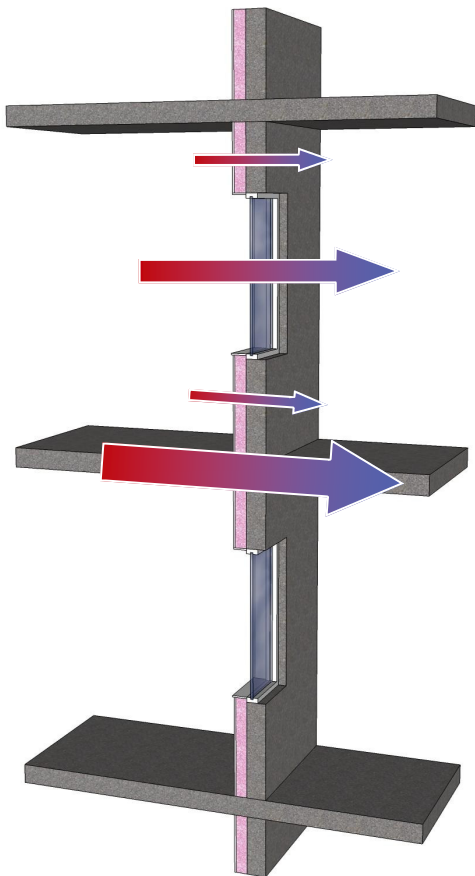

Thermal bridging paths through the enclosure of a concrete multi-storey building with balconies

### The study addresses the following topics:

- Quantification of effective R-values, linear transmittance values ( $\psi$ ), and indoor surface temperatures for various typical North American wall assemblies with and without exposed slab edges and balconies and with various balcony thermal break solutions.
- Assessment of various thermal modeling parameters including floor finishes, in-slab heating, and balcony depth.
- Comparison of the effective thermal performance of several alternate balcony thermal break solutions, insulation strategies, and manufactured thermal break products.
- Comparison of the space conditioning (heating and cooling) energy consumption for multi-unit residential buildings with exposed slab edges and balconies and with the various thermal break solutions.

**This Report #2 of 4 specifically covers the impact of balcony and slab edge thermal break products on thermal comfort and condensation control. Report #1 covers R-values and energy code compliance and Report #3 covers energy modeling along with energy and cost savings. Report #4 covers thermal modeling considerations and alternate systems.**



## Methodology: Thermal Modeling of Exposed Concrete Slab Edges for Thermal Comfort and Condensation

Thermal bridging at concrete slab edges results in heat bypassing the wall insulation, which not only reduces the effective R-value of the entire wall but also reduces the interior surface temperatures near the interface during the colder winter months, which affects occupant comfort and the potential for surface condensation and organic growth (mould and mildew).

As part of this study, the thermal comfort impact of exposed slab edges and balconies was thermally modeled for several different wall assemblies (including window wall) commonly constructed within North America.

Effective R-values and surface temperatures were calculated using the three-dimensional finite element thermal modeling software, Heat3. This program has been validated to ISO 10211 standards and is widely used by researchers and consultants to perform advanced thermal simulations to calculate 3D effective R-values of building enclosure assemblies and details. RDH has also performed in-house confirmation of the software results with published guarded hot-box laboratory testing and ASHRAE 90.1 thermal data.

To calculate interior surface temperatures, a variety of different inputs were used within the Heat3 software. The models were created using published material properties and defined boundary conditions. Heat3 performs a finite difference calculation to determine the heat flow through the assembly, which is then divided by the temperature difference to determine the U-value. The inverse of the U-value is the R-value. Further information can be found within the Appendix.



Photograph showing condensation and organic growth on the ceiling of a concrete slab adjacent to an exposed slab edge thermal bridge. Condensation has formed here frequently as a result of colder interior surface temperatures.

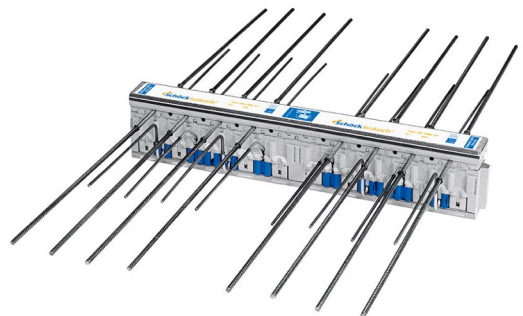

The thermal impact of purpose-built cast-in-place concrete thermal breaks such as this Schoeck Isokorb® product were evaluated within this study.

## Thermal Comfort Impact of Exposed Slab Edges & Balconies

The thermal comfort impact of exposed slab edges, eyebrows, and balconies is assessed by thermal modeling interior floor and ceiling surface temperatures for each slab edge design scenario. Cold surface temperatures of interior surfaces of walls and windows can create the feeling of drafts, lower the mean radiant temperature (the temperature of the surroundings with in which an occupant radiates heat), as well as the risk of condensation and organic growth as discussed in the subsequent section of this report.

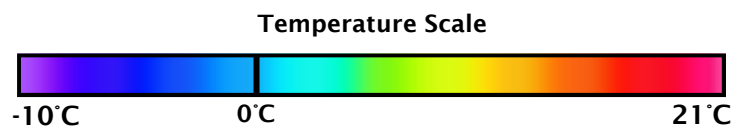
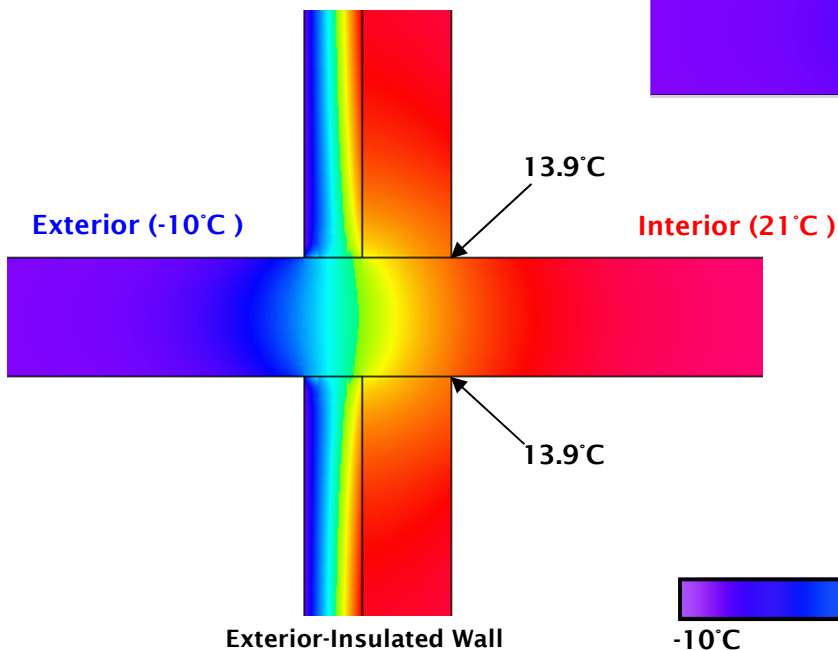
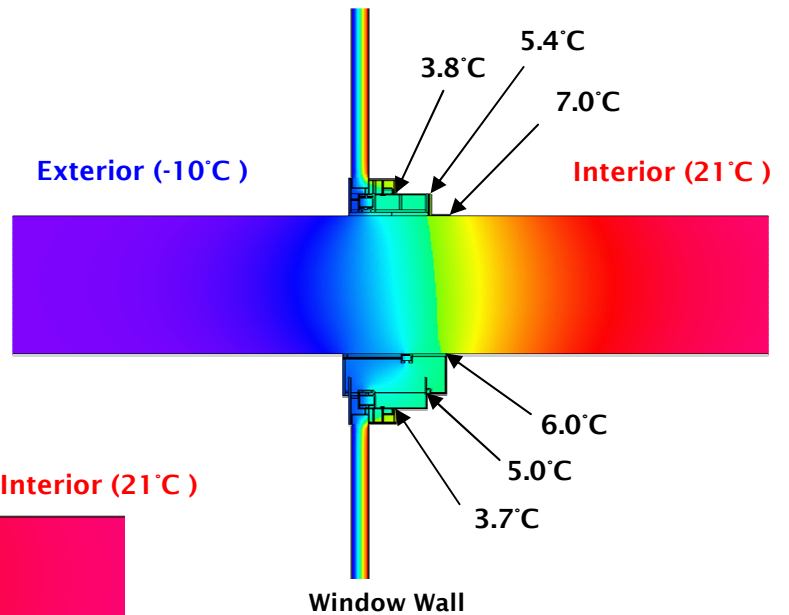
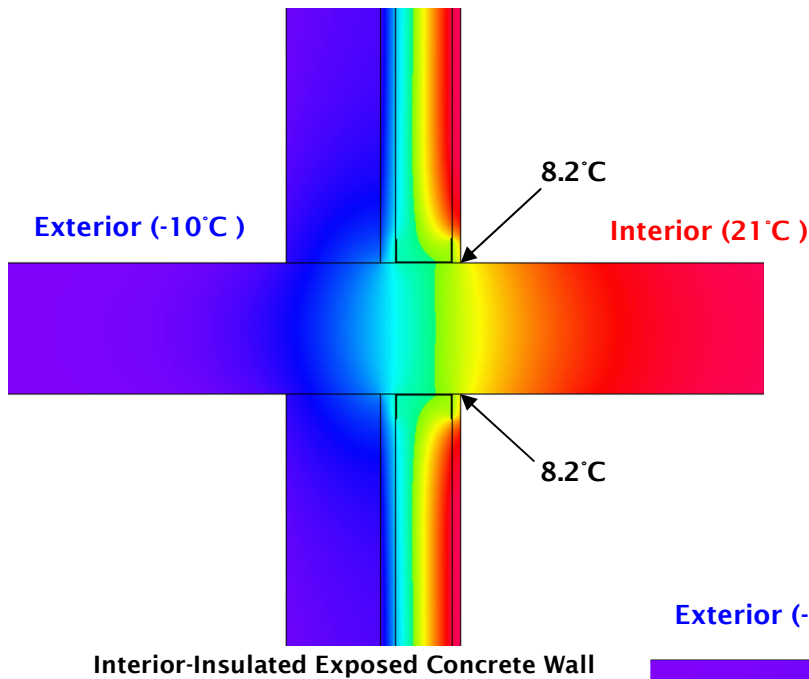
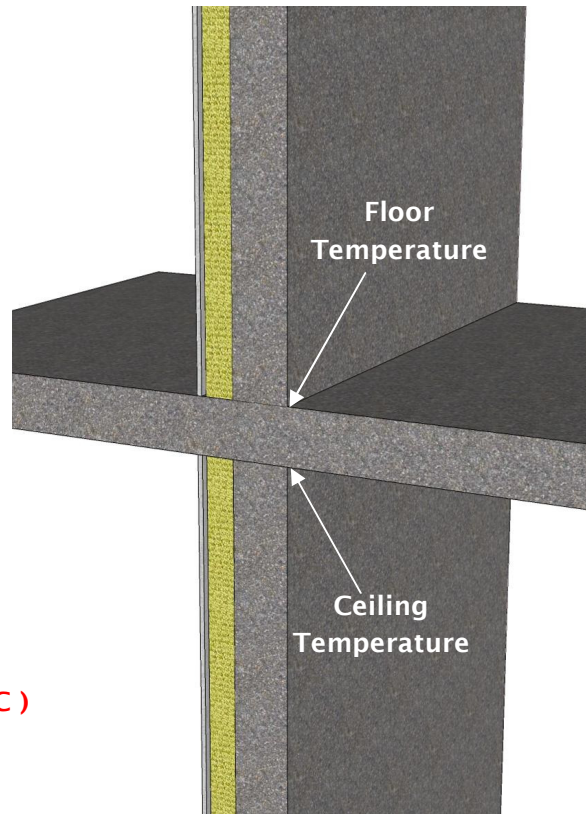

## Condensation and Mould Potential Impact of Exposed Slab Edges & Balconies

During the cold winter months, cold interior surface temperatures are not only uncomfortable to occupants but can lead to surface condensation and potentially organic growth.

The adjacent graphs provide correlations between interior temperature and relative humidity and the dew point temperature (condensation) and mould temperature. These temperatures correspond with 100% and 80% relative humidity respectively. If the temperature of the coldest point on the interior surface of the enclosure assembly is less than the temperature determined using the graphs, there is a risk of condensation and/or organic growth.

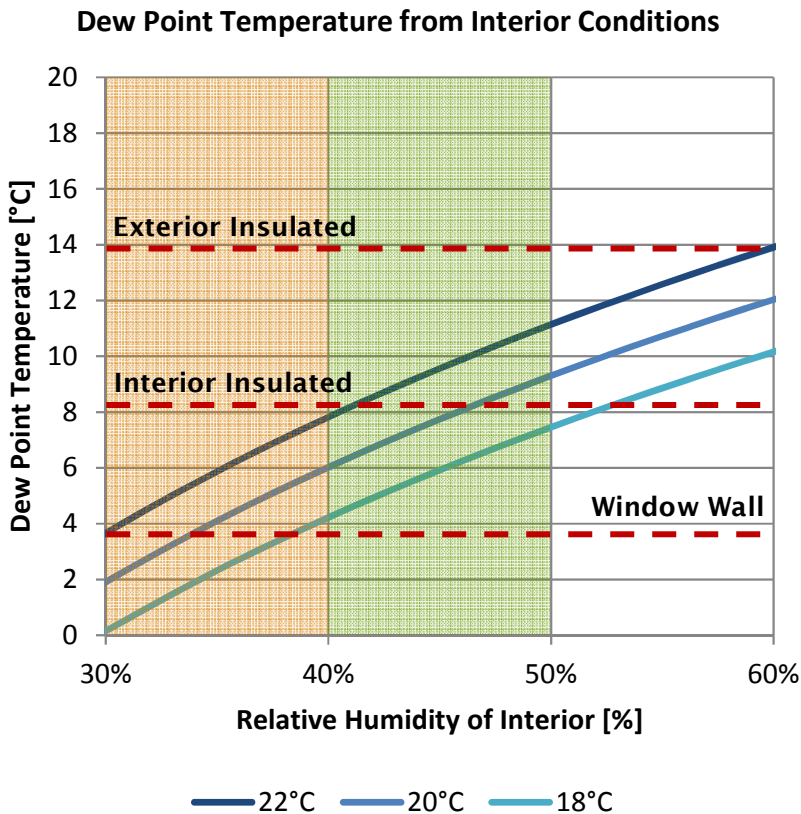
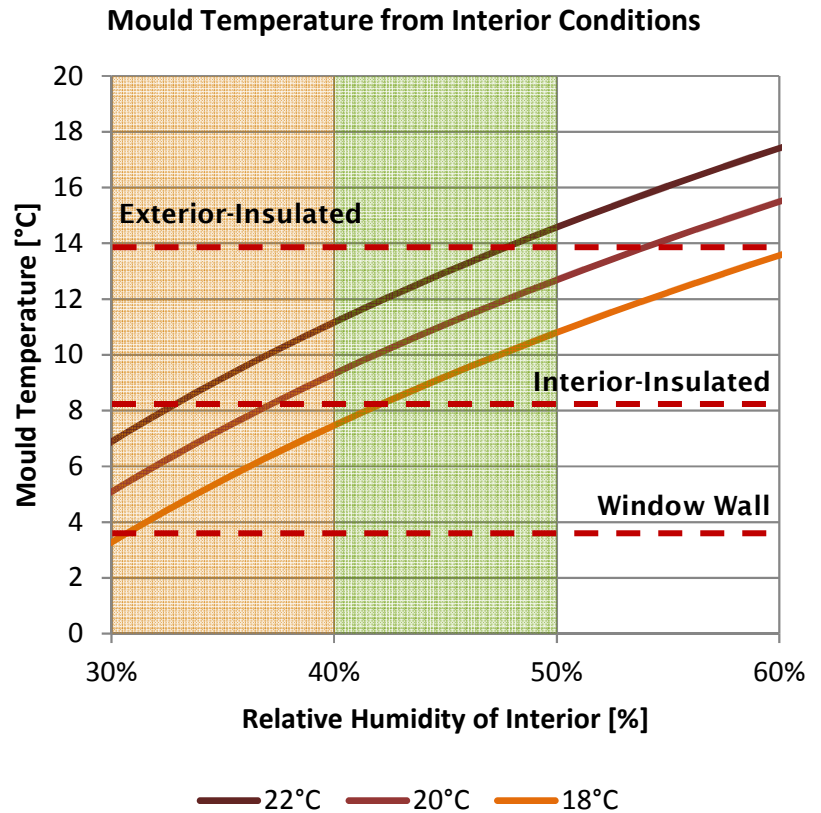

The coldest temperatures as identified in the isothermal image on the preceding page are overlaid on these graphs. For reference, North American climates and typical occupant loads and ventilation rates create typical winter month interior relative humidity levels of 40% to 50% in Climate Zones 1 to 4 and <30% to 40% in Climate Zones 5 to 8.

Temperatures on the interior surface of various assemblies and calculated temperature indices are provided in a table in the appendix of this report.

# Thermal Comfort Impact of Balcony Slab Edge Thermal Breaks

The thermal comfort impact of balcony slab edge thermal breaks is assessed by thermal modeling of interior floor and ceiling surface temperatures for each slab edge design scenario with and without a thermal break installed. Balcony slab edge thermal breaks provide an opportunity to increase interior surface temperatures and thus improve thermal comfort.

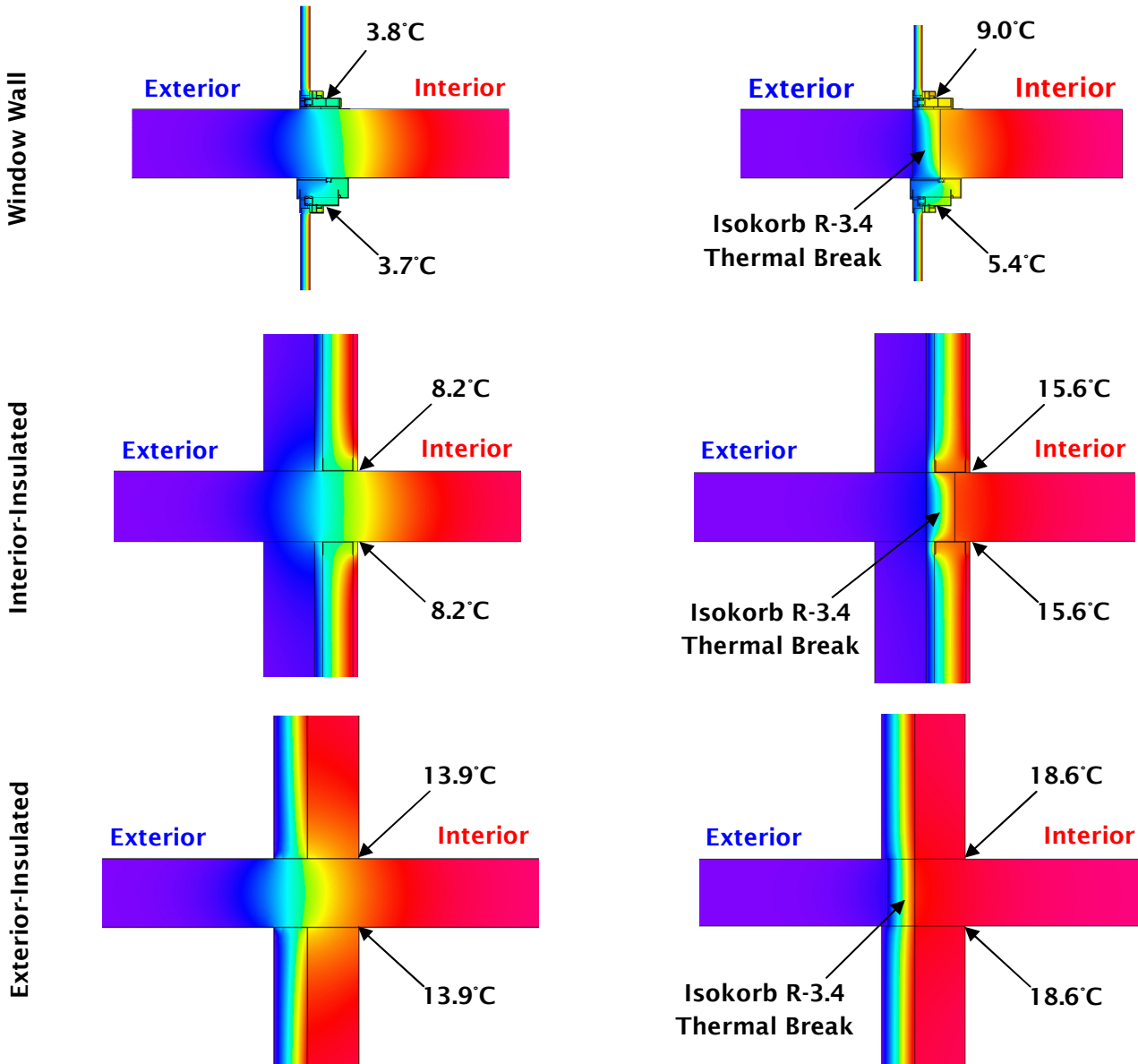
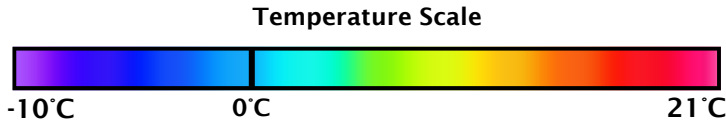
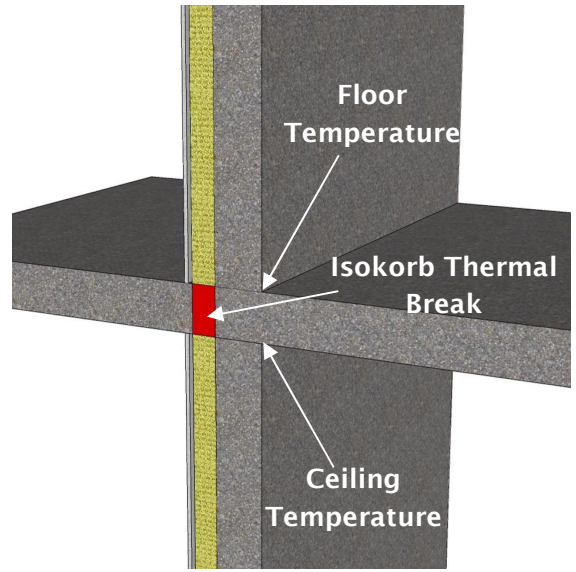



# Condensation and Mould Potential Impact of Balcony Slab Edge Thermal Breaks

During the winter months, cold interior surface temperatures are not only uncomfortable to occupants but can lead to surface condensation and potentially organic growth.

The adjacent graphs provide correlations between interior temperature and relative humidity and the dew point temperature (condensation) and mould temperature. These temperatures correspond with 100% and 80% relative humidity respectively. If the temperature of the coldest point on the interior surface of the enclosure assembly is less than the temperature determined using the graphs, there is a risk of condensation and/or organic growth.

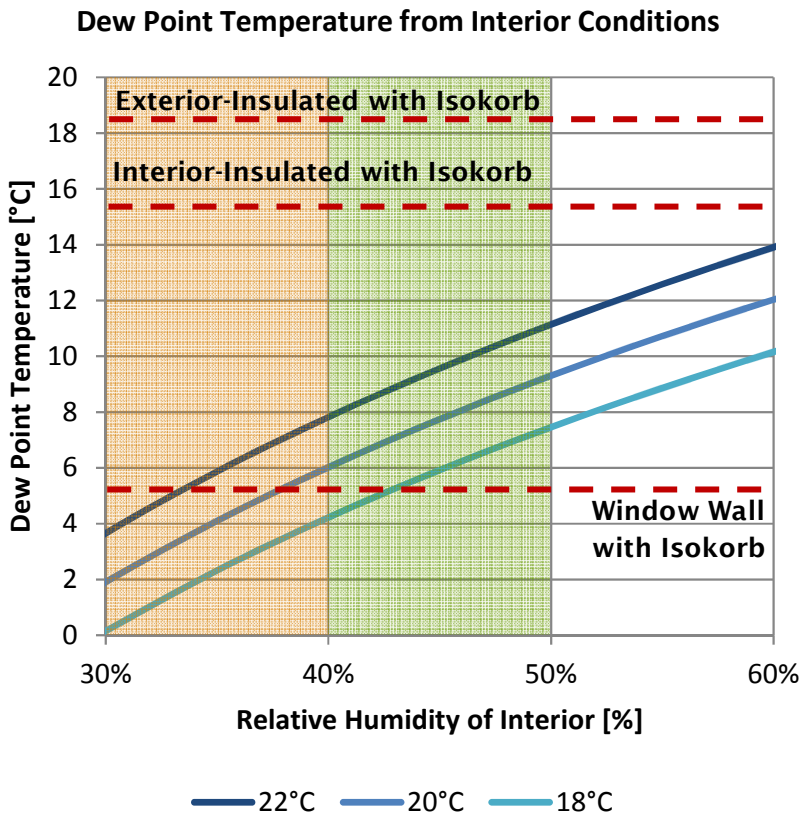
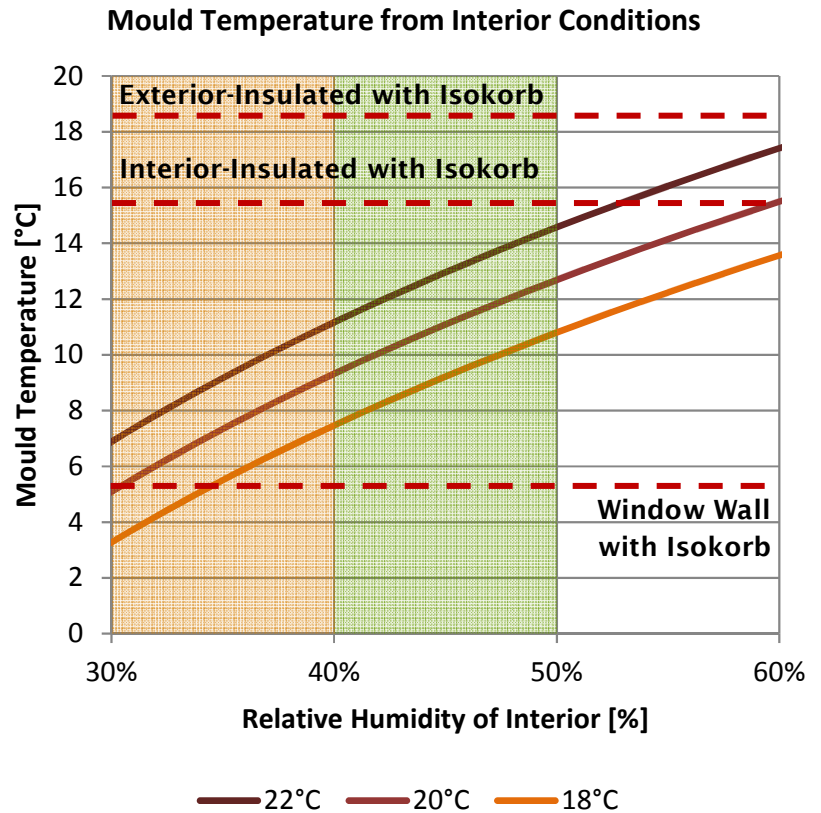

The coldest temperatures as identified in the isothermal image on the preceding page are overlaid on these graphs. For reference, North American climates and typical occupant loads create typical wintertime interior relative humidity levels of 40% to 50% in Climate Zones 1 to 4 and <30% to 40% in Climate Zones 5 to 8.

Temperatures on the interior surface of various assemblies and calculated temperature indices are provided in a table in the appendix of this report.



## Conclusions: Thermal Comfort and Condensation Control

Thermal bridging in building enclosure systems often significantly reduces the effective R-value of wall assemblies and affects indoor thermal comfort. As industry moves toward higher R-value assemblies to meet more stringent building codes, energy standards, and occupant expectations in terms of thermal comfort and condensation control, the reduction of this thermal bridging will be necessary. In many high-rise buildings, exposed concrete slab edges, balconies, and eyebrows are one of the most significant thermal bridging elements and are a large source of thermal comfort complaints and condensation.

The incorporation of cast-in-place concrete slab thermal break systems can significantly improve building enclosure thermal performance. The interior surface temperatures during winter conditions are increased, which reduces the potential for condensation and organic growth and improves thermal comfort for building occupants. Both slab and wall surface temperatures are positively affected.

Overall, balcony slab edge thermal break systems provide architectural freedom to designers while maintaining the thermal performance characteristics of the building to reduce building energy consumption, improve thermal comfort, and meet increasingly stringent building code requirements. While these systems are currently uncommon in typical North American construction, as the industry develops, the incorporation of these systems into building design will likely become increasingly commonplace.

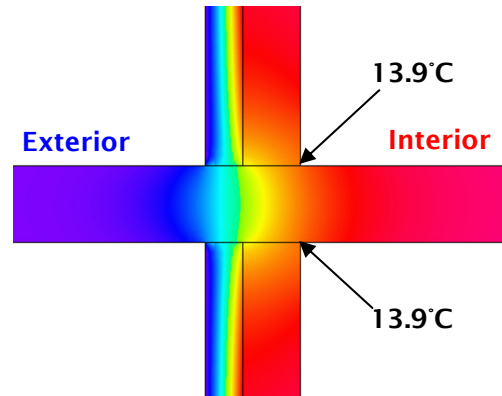

Temperature plot showing the impact of a cast-in-place concrete balcony slab edge thermal break (below) vs. a typical uninsulated condition (above).

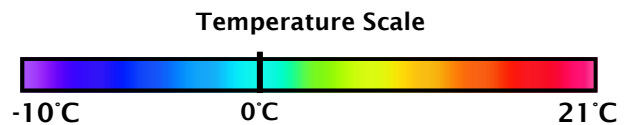
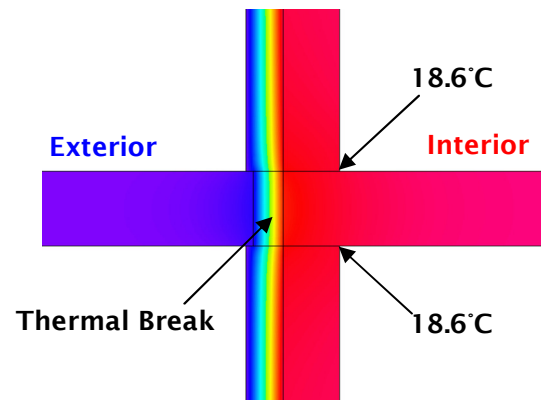

## Appendix: Thermal Modeling Inputs & Material Data

## Thermal Modeling: Determination of R-Values, U-values, and Linear Transmittance ( $\psi$ )

The effective R-values for several typical wall assemblies with varying insulation levels were calculated using the three-dimensional finite element thermal modeling software, Heat3. This program has been validated to ISO 10211 standards and is widely used by researchers and consultants to perform advanced thermal simulations to calculate 3D effective R-values of building enclosure assemblies and details. RDH has also performed in-house confirmation of the software results with published guarded hot-box laboratory and ASHRAE 90.1 thermal data.

To calculate R-values, a variety of different inputs were used within the Heat3 software. The models were created using the material properties provided on the following page and the boundary conditions as defined in the table below and illustrated in the image to the right. The exterior temperature was changed from the standard  $-17.8^{\circ}\text{C}$  to  $-10^{\circ}\text{C}$  to be more indicative of typical exterior conditions for the calculation of surface temperatures. Heat3 performs a finite difference calculation to determine the heat flow through the assembly, which is then divided by the temperature difference to determine U-value. The inverse of the U-value is the R-value.

Linear transmittance was calculated by first modeling the wall without a slab edge or balcony and then modelling it with the slab edge or balcony detail to determine their respective U-values. Then, the formula below was used to calculate linear transmittance ( $\psi$ ).

$$\Psi = \frac{(U_{Wall - WithSlabEdge} - U_{Wall - NoSlabEdge}) \cdot A_{wall}}{L_{slab}}$$

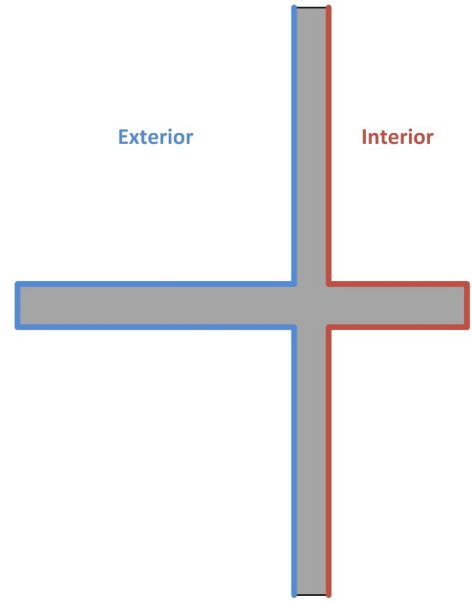

Boundary Conditions - R-Value Models

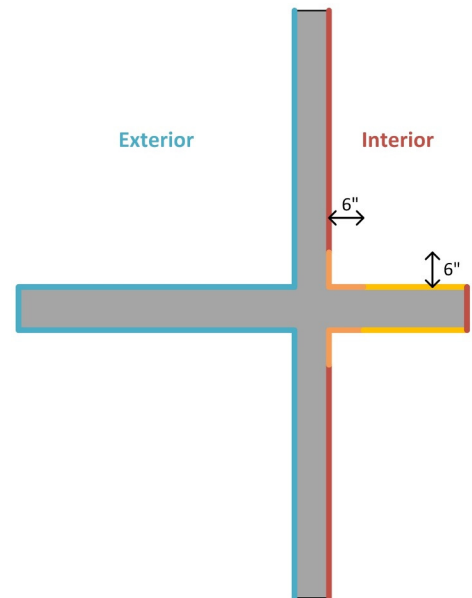

Boundary Conditions - Surface Temperature Models

Boundary Condition	Temperature ( $^{\circ}\text{C}$ )	Surface Film Coefficient ( $\text{W}/\text{m}^2\cdot\text{K}$ )
Exterior - R-Values	-17.8	23.0
Exterior - For Surface Temperatures	-10.0	23.0
Interior - R-Values	21.0	7.7
Interior - For Surface temperatures - Corner of Floor to Ceiling	21.0	4.0
Interior - For Surface Temperatures - Floor and Ceiling	21.0	6.0
Interior - For Surface Temperatures - Wall	21.0	7.7

## Material Properties for Thermal Modeling

The following material properties were used within the Heat3 thermal models used to calculate Effective R-values and temperatures to assess thermal comfort. These properties are based on published material data from numerous industry sources including ASHRAE, NRC, and product manufacturers.

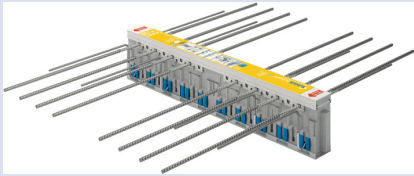
Material Description		Thermal Conductivity, k (W/m · K)
<b>Mineral Fiber or Fiberglass Insulation</b>	R-3.0/inch Batts	0.048
	R-3.4/inch Batts	0.042
	R-3.6/inch Batts	0.040
	R-3.8/inch Batts	0.038
	R-4.2/inch Cavity Insulation	0.034
<b>Extruded Polystyrene</b>	R-5/inch Board	0.029
<b>Expanded Polystyrene</b>	R-4/inch Standard Board	0.030
	R-4.6/inch Graphite-Enhanced	0.031
<b>Closed-Cell Spray Foam</b>	R-6/inch	0.024
<b>Concrete (Temperature Steel Reinforced)</b>		2.000
<b>Concrete (Light Beam Reinforced)</b>		3.000
<b>Concrete (Heavy Beam Reinforced)</b>		4.700
<b>Steel</b>	Galvanized Sheet (studs/girts)	62.000
	Stainless (ANSI 304)	14.300
	Rebar	50.000
<b>Gypsum Sheathing/Drywall</b>		0.160
<b>Ventilated Airspace</b>		0.450
<b>Wood</b>	Framing	0.140
	Plywood	0.110
<b>Stucco (Cement-Lime)</b>		0.720
<b>Brick (North American Clay Brick)</b>		0.450
Balcony/Slab Edge Thermal Break – Schoeck Isokorb, Range of values for standard products. Actual project values will depend on structural requirements for balcony support.  	R-2.5 (80 mm, 3.25")	0.181
	R-3.4 (80 mm, 3.25")	0.134
	R-3.4 (120 mm, 5")	0.200
	R-4.5 (120 mm, 5")	0.151
	R-5.0 (120 mm, 5")	0.135
	R-5.7 (120 mm, 5")	0.120